

# INSTALLATION INSTRUCTIONS











**TOILET | ENGLEFIELD D-SHAPE BIDET SEAT 38549A-0**



# 1. SAFETY INSTRUCTIONS

- Be sure to read the following safety instructions carefully and use the product only as instructed in this manual to prevent bodily injuries and / or property damage which might happen while using this product.
- Thoroughly understand each of the following symbols (marks and graphical signs), read all instructions and precautions and follow them.

 <b>WARNING</b> Failure to observe any of the following might result in critical injury or death.	 <b>CAUTION</b> Failure to observe any of the following might result in minor injury and/or product damage.
 Strictly prohibited.	 Be sure to unplug the electric power plug.
 Never disassemble or modify this product.	 Do not place in or drop into water.
 Proper grounding required.	 Things that have to be observed.
 Never use wet hands.	

- i. Serious injury includes loss of eyesight, severe wound, burn, electric shock, bone fracture, etc.
- ii. Injury means minor wound, burn or electric shock.
- iii. Property damage refers to extensive damage relating to house, furniture, livestock or pet, etc.

## EXEMPTION FROM LIABILITY:

- Kohler New Zealand (KNZ) takes no responsibility for any damages resulting from natural disasters such as earthquakes, lightning and wind damage and flooding, fires not caused by the KNZ or the bidet product covered by this manual, other accidents, consumer mistakes and/or misuse and abuse of the product or the use of the product under abnormal conditions.
- KNZ takes no responsibility for any incidental damages resulting from the use of the product or inability to use the product (lost profits or suspension of business, etc).
- KNZ takes no responsibility for any damages resulting from the failure to observe the contents contained in this manual.

 **WARNING**

When children, the elderly or the invalid use the product, the water, drying & seat temperature shall be set to LOW position.

Do not scratch, crack, bend forcibly, twist or pull the electrical power cord. Do not apply heat to, or place heavy objects on the cord.

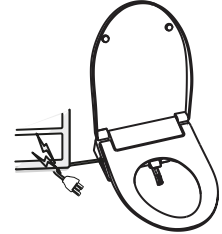

Use a dedicated electric wall outlet which is suitable for AC 230V.

Do not disassemble, repair or modify the product. Doing so may cause fire, electric shock or injury. Contact an authorised service centre as listed on the last page for repair.

Use of extension cord or sharing an outlet with other products may lead to fire or electric shock.

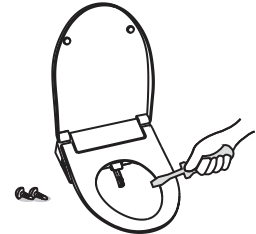
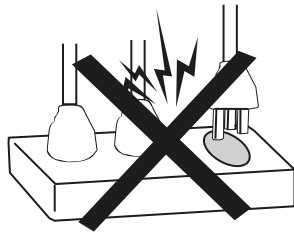

Never use a damaged power cord, damaged power plug, or a loose electrical outlet. Doing so may result in fire, electric shock, short circuit. Contact an authorised service centre as listed on the last page for repair.

Power plug shall be plugged into the wall outlet securely. Failure to do so may result in electric short circuit, smoke generation or ignition.

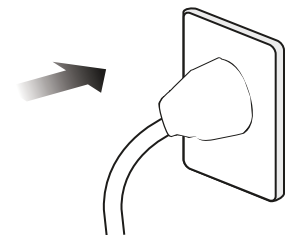
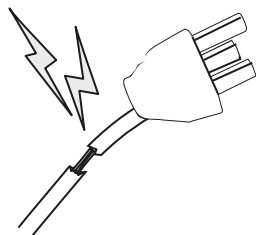

Disconnect the power plug from the wall outlet when the product will not be used over an extended period of time.

Do not install the product in wet or damp places. This product is intended for use on a toilet only, and shall not be used for any other purpose.

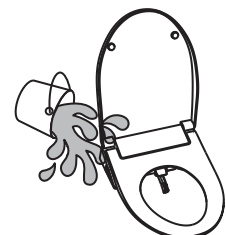
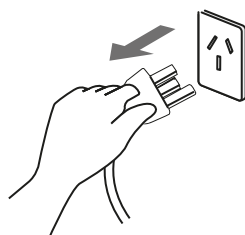

Use tap water or potable water only. Using recycled water or industrial water may cause cystitis or irritation to skin.



Use tap water

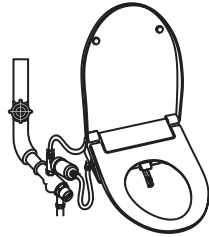

Do not spray water or wastewater into the unit or power plug. Doing so may cause fire or electric shock.



Prohibited

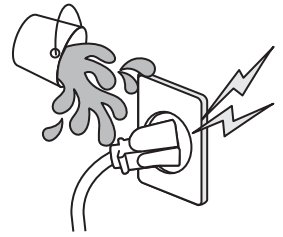

Keep power plug dust-free by removing the dust using a dry cloth. Failure to do so may cause a fire.



Wipe off



When plugging and unplugging the power plug, never use wet hands. Doing so may lead to electric shock.



Wet hands prohibited

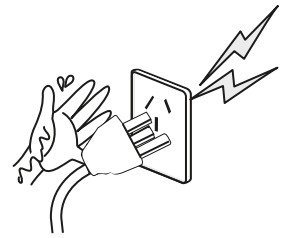

Before cleaning the product, always disconnect the power plug. Failure to do so may cause electric shock or injury.



Disconnect power plug

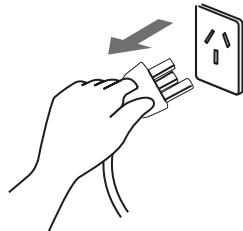

## **WARNING**

### **Discontinue using the product in case of malfunction.**

Disconnect the power plug from the wall outlet and close the angle valve if any of the following occur.

- Water leaks from either the main unit or the water pipe.
- The product makes odd noises or produces an unpleasant odour.
- Abnormal heat from the main body.
- Fumes emitting from the main unit.
- Crack or break on the main body.

Continuing use of a malfunctioning product may lead to fire, electric shock or water leakage. Please contact an authorised service centre as listed on the last page for repair.



**CAUTION**

Do not use the product other than that described in this user manual. Failure to do so may lead to fire, electric shock or injury.

Grasp only the plug knob for unplugging the power plug. Failure to do so may result in electric shock, electric short circuit or fire.

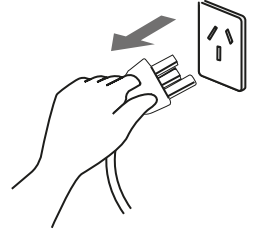
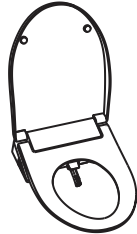

Do not place hot and flammable materials in or near the product. Doing so may lead to fire, discolouration or malfunction.

Do not rest against the seat cover when sitting on the seat. This may damage the seat cover and may cause personal injury.

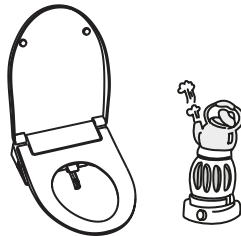

Do not spray water, insert fingers or other objects into the warm air blower outlet or nozzle opening. Doing so may result in burn, injury, electric shock, or malfunction.

Do not let a child use this product alone.

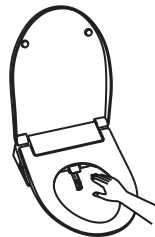

Shut off the angle valve before removing the filter in the water inlet hose for cleaning.

Do not bend or twist the water inlet hose. Doing so may cause water leakage.

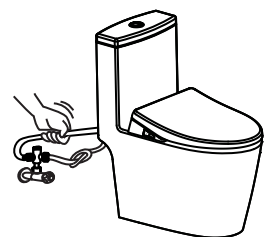
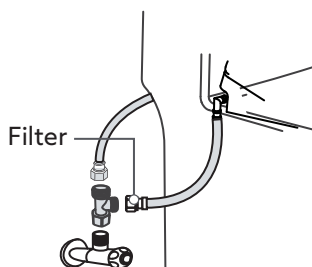

Do not expose the product directly to sunlight or strong light. Doing so may cause product surface fading, discolouration or degradation.

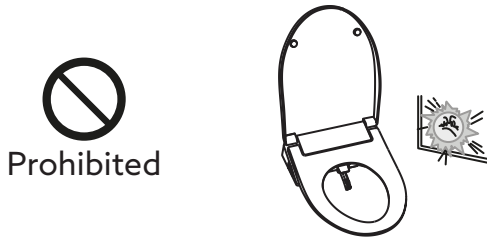

Do not stand on or place heavy objects on the cover. Doing so may lead to deformation or breakage of the product or personal injury.

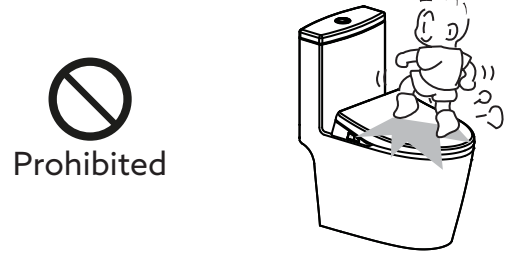

Never use acidic or alkaline bathroom detergent, benzene, thinner, cleanser or nylon scrubber when cleaning the product. Doing so may damage plastic or metallic parts.



Do not place or drop the product into water. It may lead to a product failure or electric shock.



Do not throw glowing cigarettes or other burning materials in the toilet.

Do not place glowing cigarettes in a conspicuous place beside the toilet.



Do not insert fingers or other objects into the deodorization cassette housing. Doing so may lead to injury of fingers due to rotating fan.

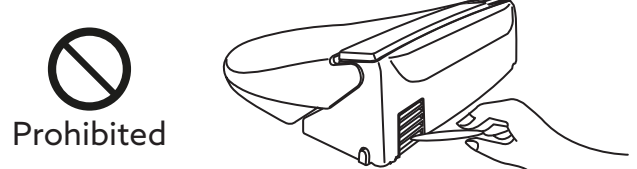

This bidet seat is designed for a maximum user weight of 150 kg.

This product is not be used by people with reduced physical, sensory or mental capabilities, or lack of experience and knowledge, unless they have been given supervision or instructions.



Individuals with conditions affecting the skin or sensitive areas, should consult a doctor before using this product.

This product is not medical equipment.



Caution

Water pressure shall be set to "Minimum Level" when the product is used by a person having sensitive skin or a disease in the sensitive private area. Failure to do so may lead to skin damage.



Caution

Do not forcibly pull or push back the nozzle.



Caution

This product must be connected to cold water supply only (water temperature 4°C~35°C). Failure to do so may cause product faults or damage.



Caution

Do not open/close the bidet seat and cover using excessive force. Doing so may lead to breakage or malfunction.



Caution

When the product is not used for a long time,

- Unplug the power plug
- Close the angle valve
- Disconnect the water inlet hose from the angle valve and drain the water in the hose.



Caution

Water will run out of the nozzle for 5 seconds before / after washing. It does not indicate a malfunction. It is the water from the nozzle self-cleaning operation.

If water runs continually in an unusual manner, close off the water inlet valve & unplug the power cord & contact an authorised service centre immediately for assistance.



Caution

Clean the nozzle gate and warm air blower outlet regularly to prevent possible staining from urine or the other contaminants. Failure to do so may also cause bad odour or product malfunction.

Do not press the remote buttons with excessive force.











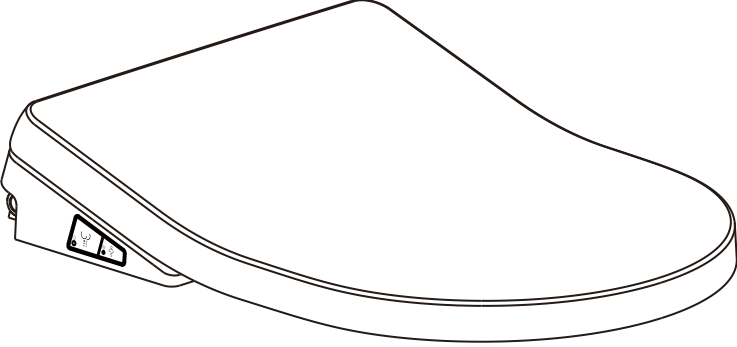
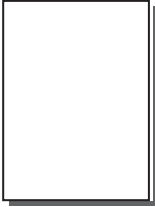

Caution

Replace batteries in the remote periodically to ensure correct operation.

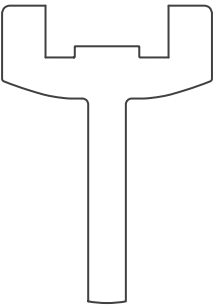
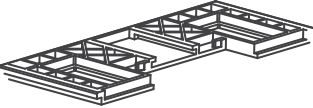
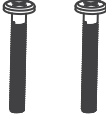
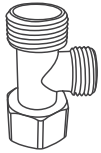
Avoid placing objects between remote and main unit, as this may interfere with correct operation.

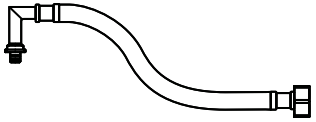
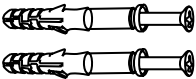
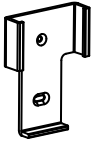
## 2. PRODUCT OVERVIEW

### 2.1 Contents

 <p>Main unit x 1</p>	 <p>Installation instruction x1</p>
 <p>Round washer x 2</p>  <p>Flat washer x 2</p>  <p>Expansion bush x 2</p>  <p>Mounting template x 1</p>  <p>Mounting plate x 1</p>  <p>Fixing screw x 2</p>	 <p>T connector x 1</p>  <p>Hose clamp x 1</p>  <p>Water inlet hose x 1</p>
 <p>Mounting screw set x 2</p>  <p>Remote holder x 1</p>  <p>Double-side tape x 1</p>  <p>Remote x 1</p>	 <p>Button battery x 2 (Model: CR2032) (Not included)</p> <p><b>Warning:</b></p> <ol style="list-style-type: none"> <li>1. Always purchase the correct size and grade of battery most suitable for the intended use.</li> <li>2. Replace all batteries of a set at the same time.</li> <li>3. Clean the battery contacts and also those of the device prior to battery installation.</li> <li>4. Remove batteries from a remote that is not to be used for an extended period of time.</li> <li>5. Remove used batteries promptly.</li> </ol>

## 2.2 Product Dimensions

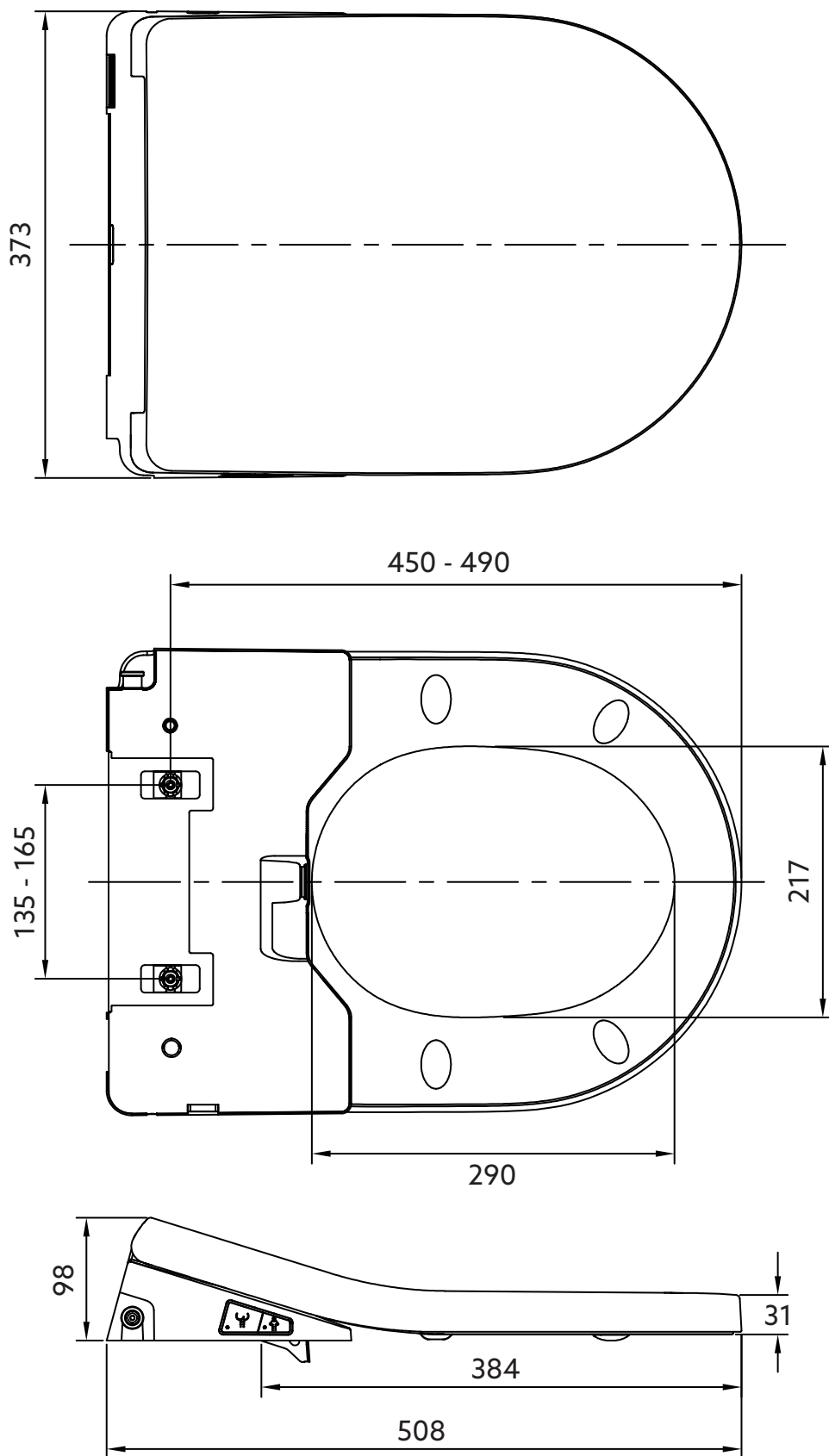

All dimensions are in millimeters

## 2.3 Product Overview

### Main Unit

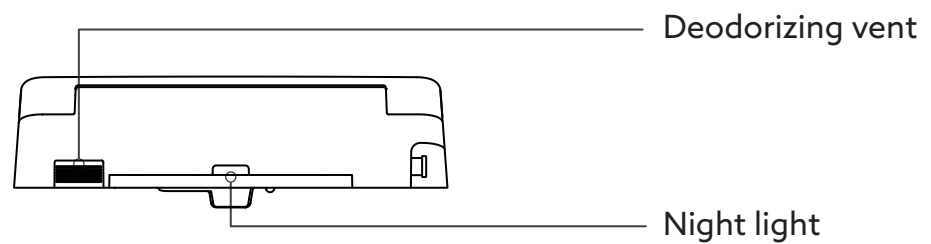
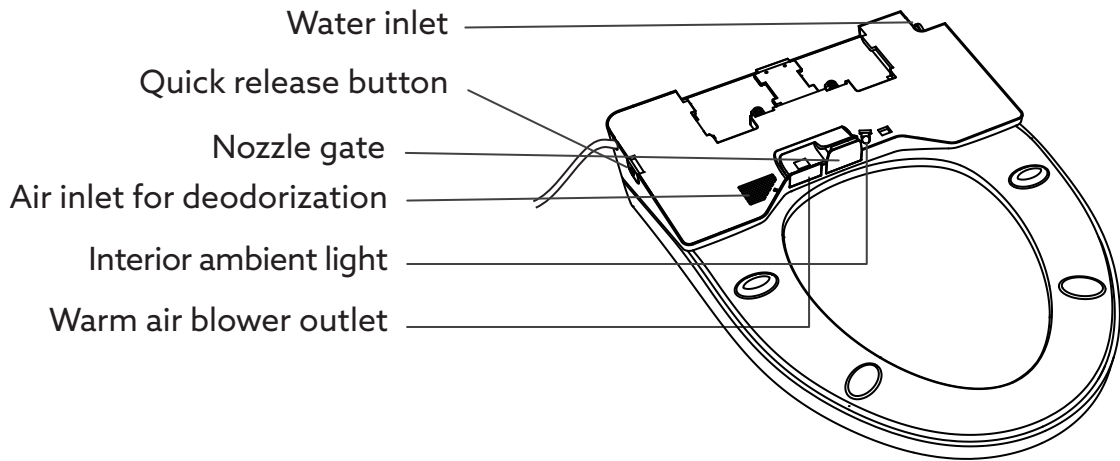
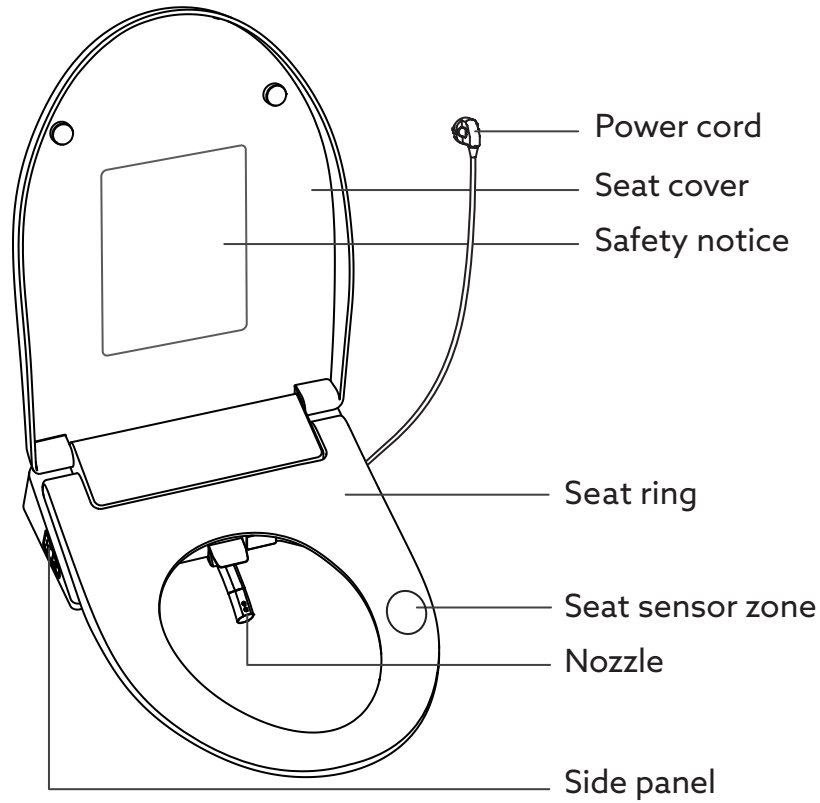

**Side Panel**

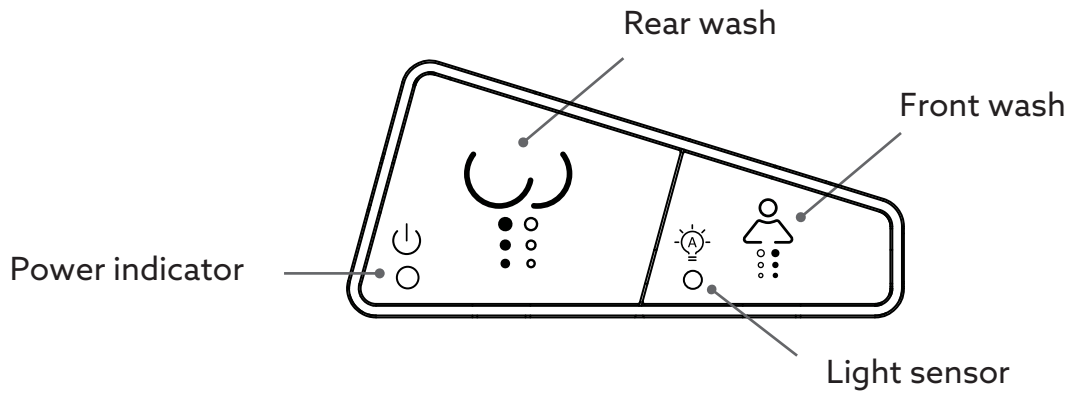

**Remote Control**

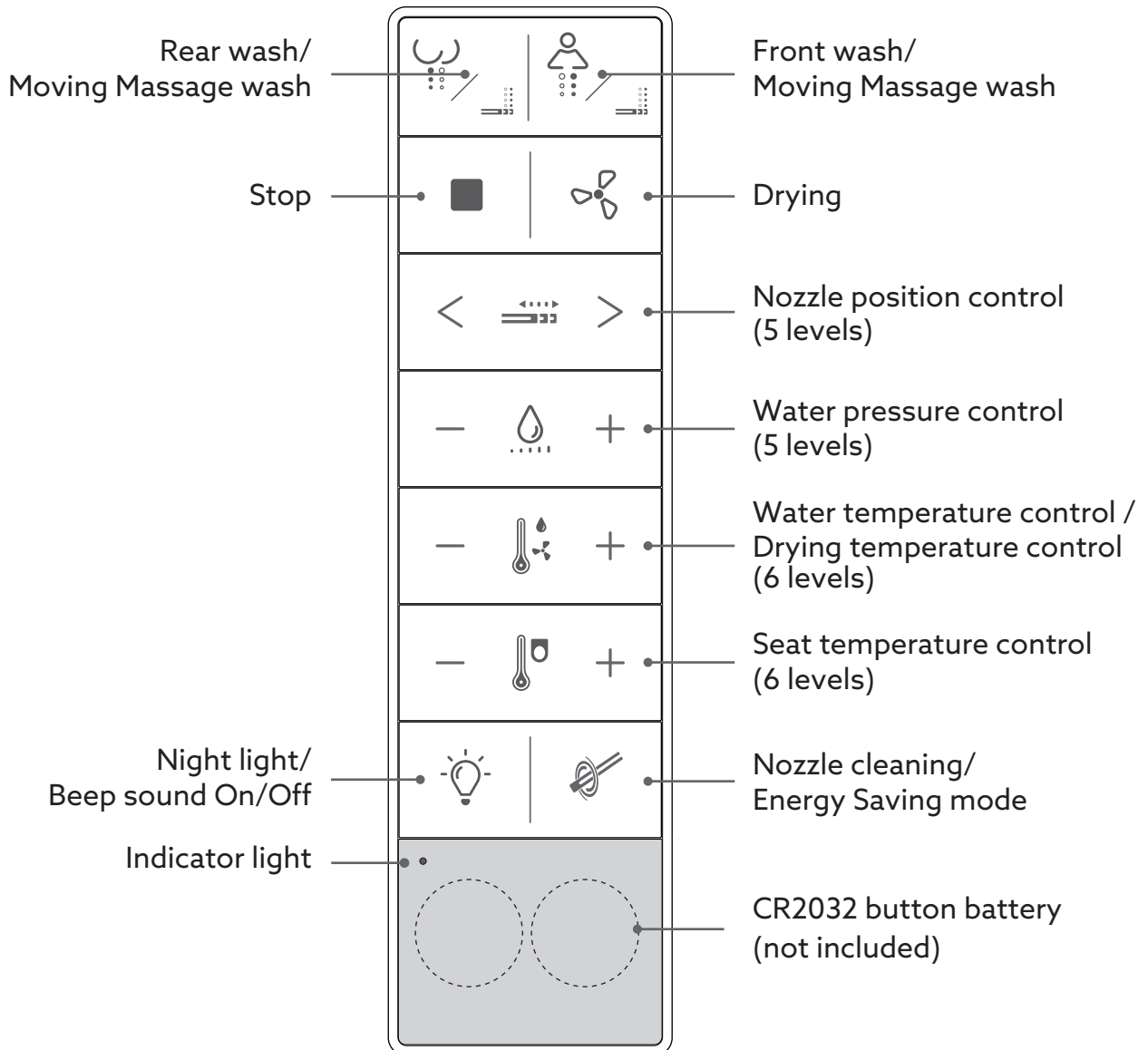

## 2.4 Technical Specification

Product code		38549A-0
Power source		AC 230V, 50Hz
Rated power consumption		1050 W
Deodorization method		Catalytic deodorization
Ingress Protection rating		IPX4
Net weight		3.8 Kg
Size		508mm x 373mm x 98 mm
Ambient temp. & humidity range		4°C-40°C, relative humidity ≤ 95%
Length of power cord		Effective length≥1.5m (with ground wire)
Warm water cleansing device	Inlet water pressure	75 kPa - 500 kPa
	Inlet water temperature	4°C - 35°C
	Warm water heating method	Instant heating
	Cleansing water flow rate	5 levels, 450 - 550 ml/min
	Nozzle position	5 positions
	Maximum heating power	1400W
	Water temperature control	6 levels
	Safety devices	Non-resettable thermal circuit breaker, auto-thermostat
Seat heater	Seat temperature control	6 levels
	Heating power	50W
	Safety devices	Temperature sensor, temperature fuse
Dryer device	Minimum dry air volume	0.2m <sup>3</sup> /min
	Maximum heating power	230W
	Drying cycle	3 mins
	Dry air temperature control	6 levels
	Safety devices	Temperature controller, temperature fuse

### 3. INSTALLATION INSTRUCTIONS

#### IMPORTANT NOTES:

- Connect to mains cold water supply only. **DO NOT** connect to hot water supply.
- Inlet water pressure range: 75kPa - 500kPa.
- Inlet water temperature range: 4°C - 35°C
- Ambient temperature range: 4°C - 40°C. Humidity range is  $\leq 95\%$ .
- This bidet seat must be installed with a Residual Current Device (RCD) protection.
- Installation shall be in accordance with Plumbing Code of Australia (PCA) in Australia.
- Installation shall be in compliance with AS/NZS3500.1 in Australia & New Zealand.
- This bidet seat has an integral **Atmospheric Vacuum Breaker (AVB)** that is independently tested to & complies with AS/NZS2845.1 - Water Supply Backflow Prevention Devices.  
**NOTE:** Local authorities may have varying requirements. Check to confirm if any additional **Reduced Pressure Zone Device (RPZD)** is still required.

#### 3.1 Toilet Compatibility Guide

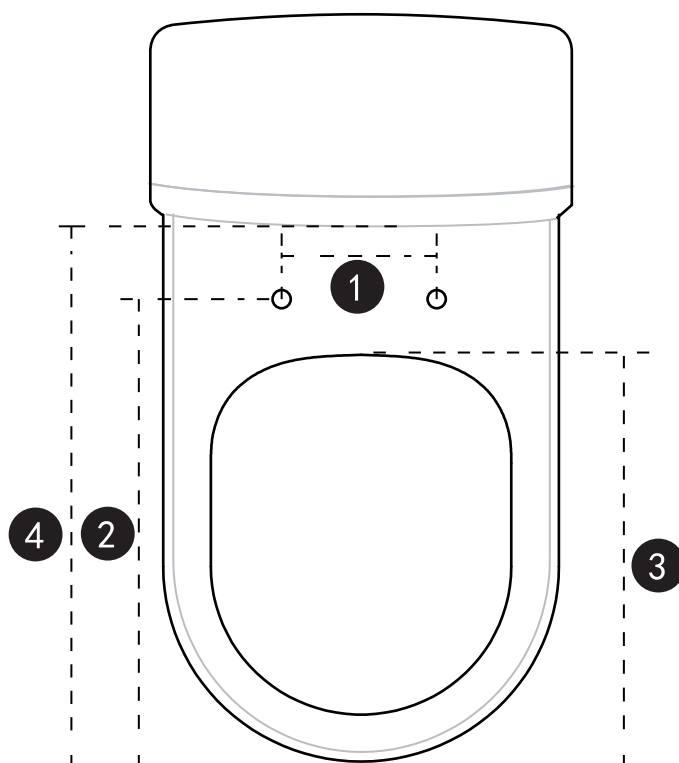

- ① Distance between seat mounting holes: 135-165mm
- ② Distance between the seat mounting holes and the front of toilet pan: 430-470mm
- ③ Distance from the inner circle of toilet pan to the front of toilet pan: >375mm
- ④ Distance from the toilet cistern to the front of toilet pan: >505mm

### 3.2 Product Installation

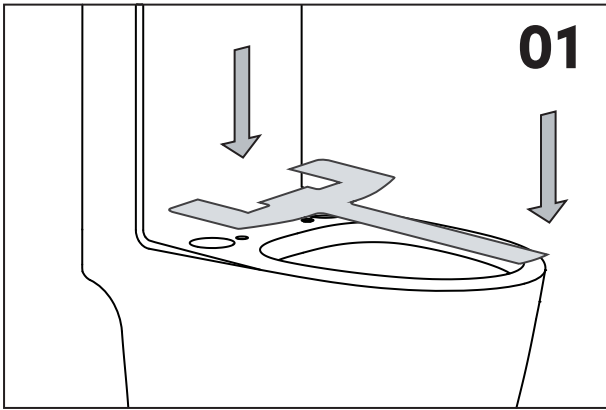

Place the mounting template on top of toilet pan as shown & align the front edge with the front of pan rim.

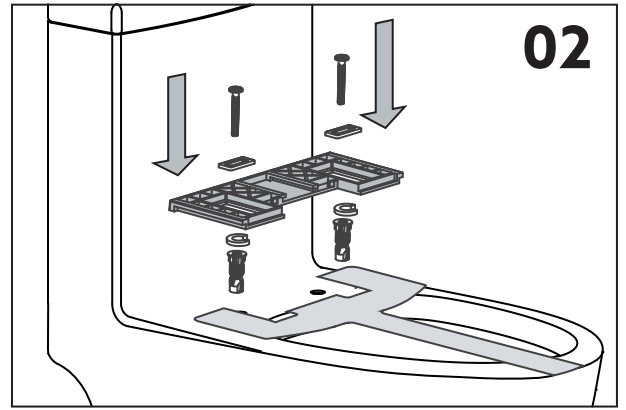

Insert the expansion bushes into the seat mounting holes & install the mounting plate onto the toilet using the supplied fixings as shown.

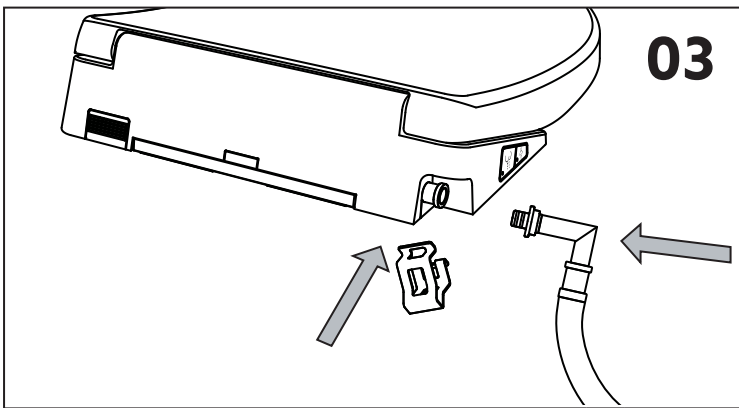

Connect the water inlet hose to the water inlet connector and secure the connection with the supplied hose clamp.

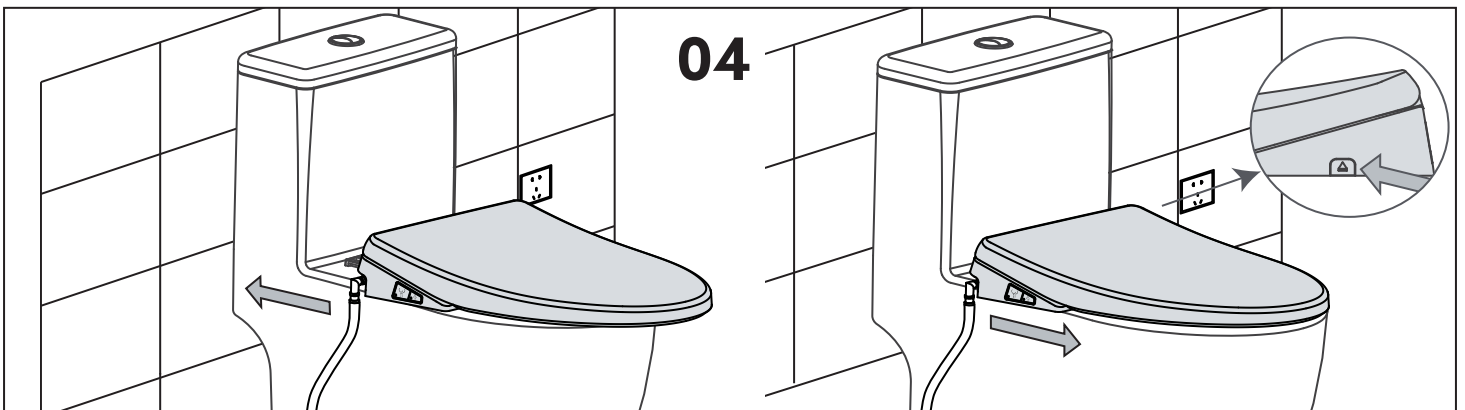

To install the bidet seat, align it with the mounting plate and slide it towards the toilet cistern until a "click" sound is heard.

To uninstall the bidet seat, press the quick-release button on the right side of bidet seat while pulling the bidet seat forward & away from the toilet cistern.

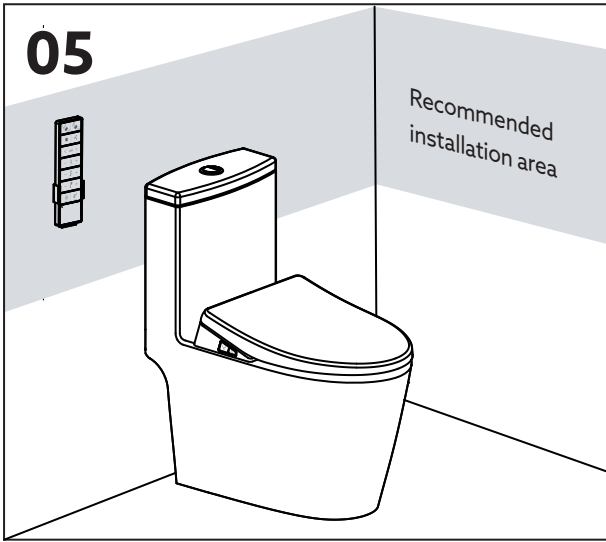

Place the remote as close to the bidet seat as possible, and choose a suitable height on the wall.

1. Install the remote holder on the wall with supplied either 3M double side tape or mounting screw set.
2. Slide the remote into the remote holder.

**⚠ WARNING**

1. To avoid malfunction or damage, do not drop or spill water onto the remote.
2. Place the remote in the remote holder when not in use.

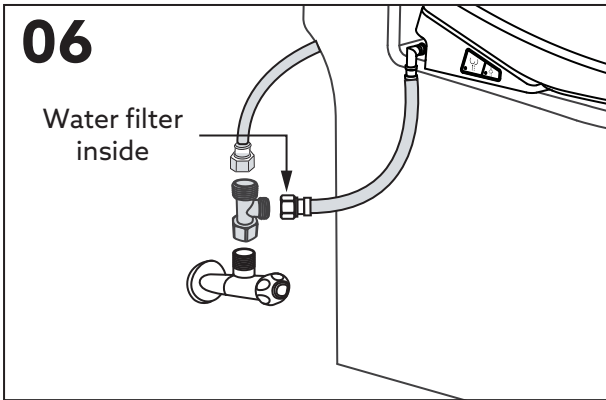

Connect the bidet seat & water inlet hose to the water supply by using the supplied T-connector if required.

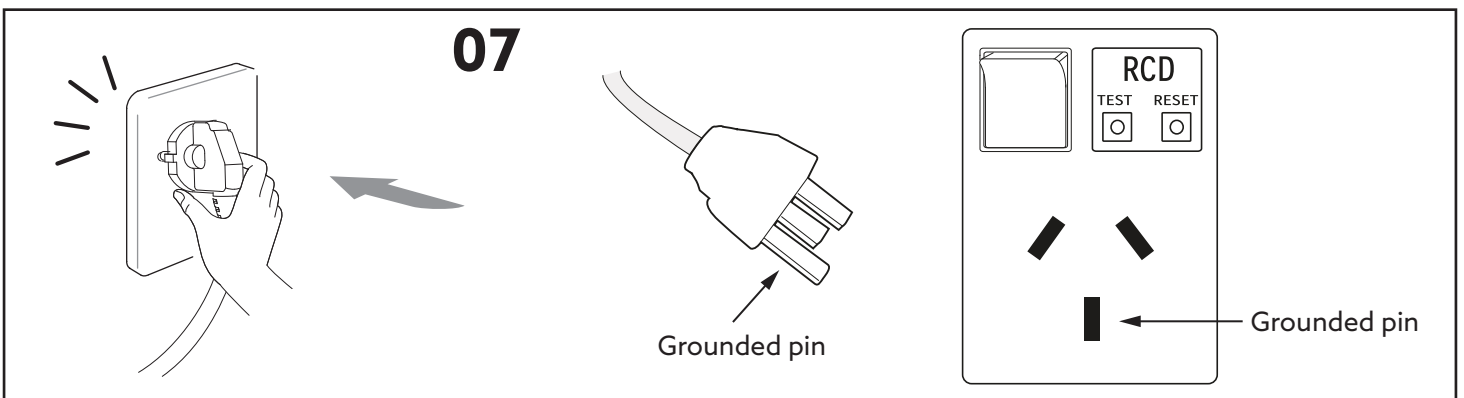

Connect the bidet seat to the power supply.

**Note:** this product must be grounded. This product is equipped with a cord having a grounding wire with a grounding pin and it must be plugged into an outlet that is properly installed & grounded.

## 4. OPERATION INSTRUCTIONS

### 4.1 Pre-Operation Check

1. Open mains water supply.
2. Open angle valve and check if there is water leaking from any pipe joints or from the bidet seat itself. If so, close water supply and fix the water leak.
3. Connect power plug to the wall outlet & check if power indicator on the side panel is on.
4. Put hand onto the **seat sensor zone** so that the bidet seat can be activated.  
**Note:** FRONT/REAR washing function only works when the product senses that someone is seated.

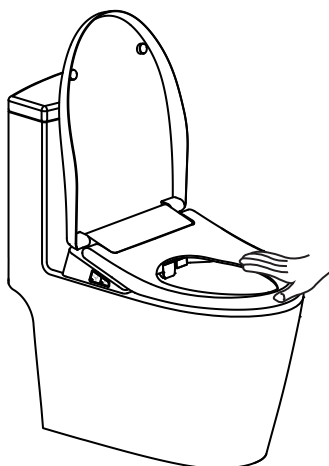

5. Press **FRONT/REAR** wash button on the side panel & check if nozzle extends and discharges water.  
**Caution:** cover the nozzle to prevent water from spraying outside the toilet pan.
6. After confirming that water is coming out from the nozzle, press **FRONT/REAR** wash button again on the side panel to terminate the washing operation.

**Note:** contact your nearest authorised service centre for further assistance if the product could not turn on or has an unreparable water leak.

### 4.2 Side Panel Operation

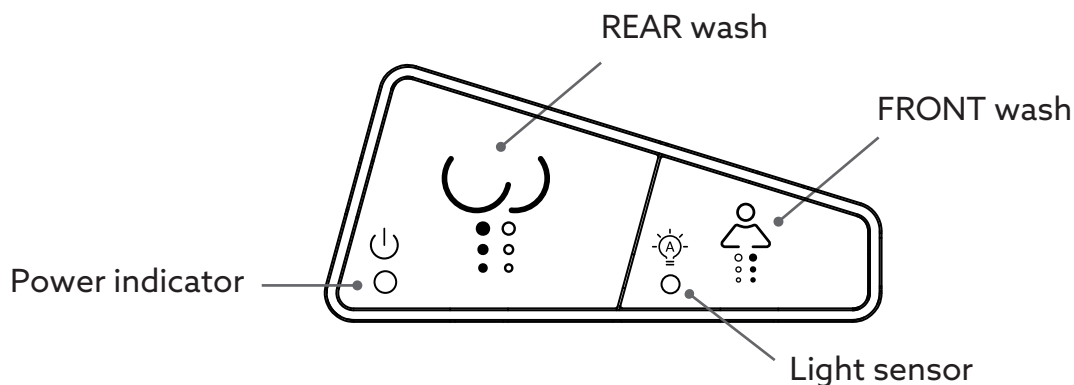

**FRONT/REAR WASH**

1. Sit on the seat & press **REAR/FRONT** wash button to start the cleansing operation.
2. The above two cleansing processes include: 15 seconds fixed point wash --> 45 seconds reciprocating wash --> 120 seconds drying operation --> stop.  
**Note:** During the above processes, water pressure, water temperature, warm air (drying) temperature, nozzle position & seat temperature can be adjusted by the remote.
3. Press **REAR/FRONT** wash button again during the running process to stop the cleansing operation.

**POWER ON/OFF**

1. Press & hold **REAR** wash button for more than 3 seconds to switch the main unit off. The **POWER INDICATOR** is turned off accordingly.
2. Press **REAR** wash button once to switch the main unit on again. The **POWER INDICATOR** is turned on accordingly.

**LIGHT SENSOR**

1. The activation of the night light & ambient light is automatically controlled by the **LIGHT SENSOR**.
2. The night light & ambient light are only automatically switched on when ambient illuminance is less than 2 Lux and is switched off once the illuminance is greater than 2 Lux.

**Note:** These two lights can be manually switched on/off with the remote when ambient illuminance is less than 2 Lux.

**4.3 Remote Operation**

**Battery Installation**

1. Open the battery cover on the front of the remote by pushing the release button up on the back as shown.
2. Install 2 x CR2032 button batteries in.

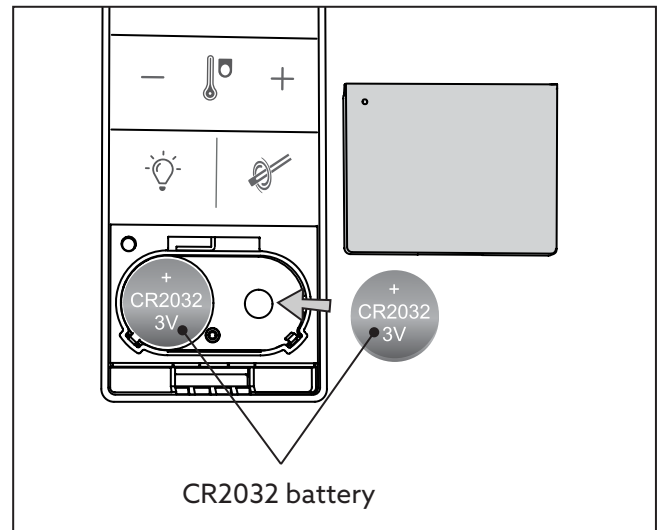
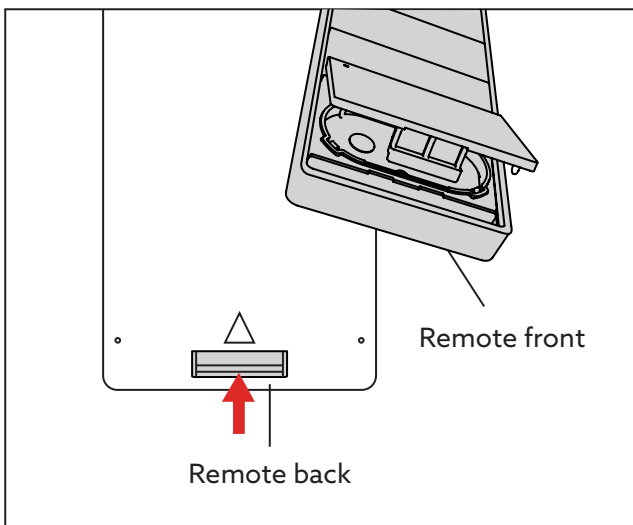

**Remote Pairing**

**Note:** The remote must be paired with the main unit before operation. The pairing process can only be performed when there is no one is sitting on the bidet seat.

1. Ensure the main unit is powered **OFF**.
2. Press & hold the **STOP** button on the remote until the indicator light on the remote starts flashing after 3 seconds.
3. While continuing to hold the **STOP** button, power **ON** the main unit.
4. Release the **STOP** button & wait for a short beep from the main unit, indicating completion of the power-on self-test.
5. Verify remote functionality by performing a basic command.

**Note:** If the remote does not operate correctly, repeat steps #1-#4.

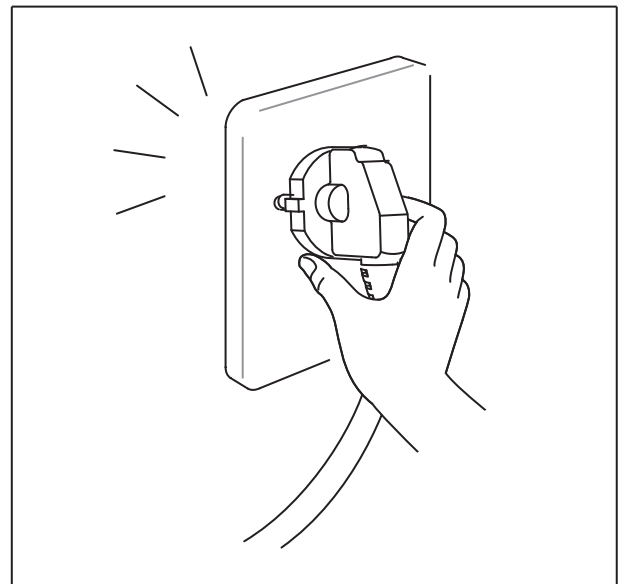
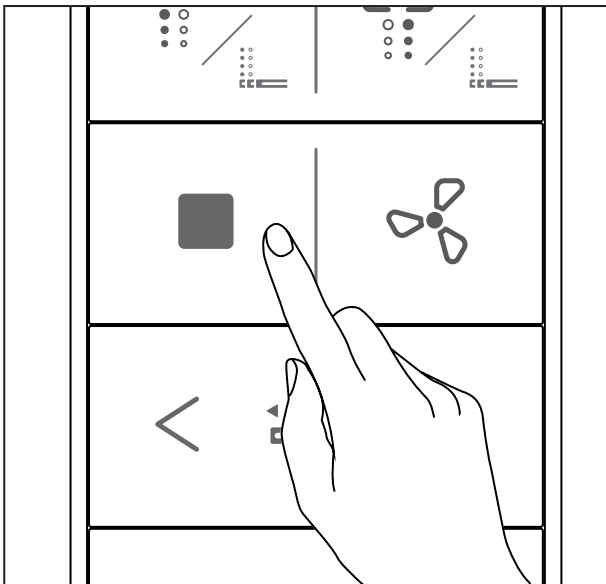

**Rear / Moving Massage Wash**

**Note:** Functions only when user is seated.

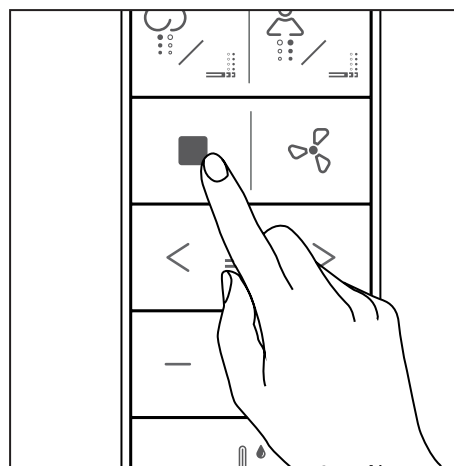
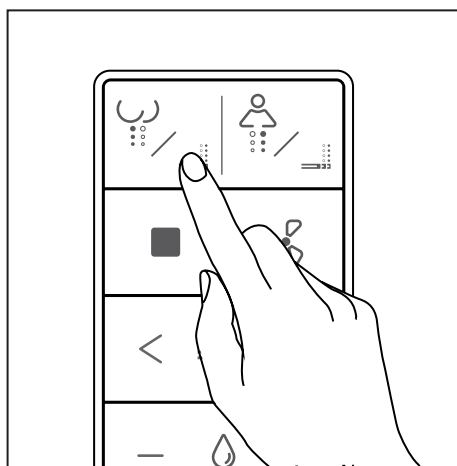

1. Press **REAR WASH** button to activate rear cleansing function. The wash cycle will start automatically and will run for 3 minutes.
2. The default cleaning mode is Fixed-Point Wash (nozzle remains in one position).
3. During the wash cycle, press the **REAR WASH** button again to change the cleaning mode: Fixed Point Wash --> Moving Wash (nozzle moves back & forth) --> Moving + Massage Wash (moving wash + alternating strong/light water pressure) --> Massage Wash --> Fixed point Wash.
4. Press **STOP** button to discontinue at any point during its operation.

**Front / Moving Massage Wash**

**Note:** Functions only when user is seated.

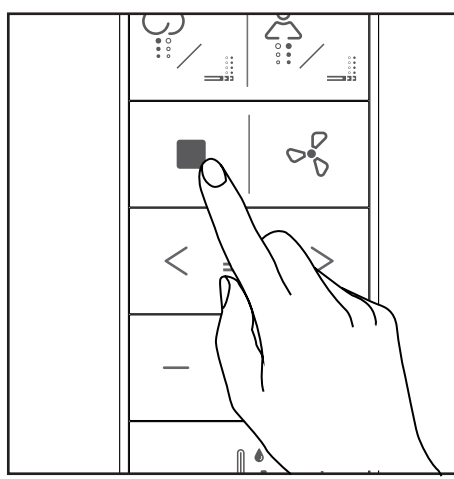
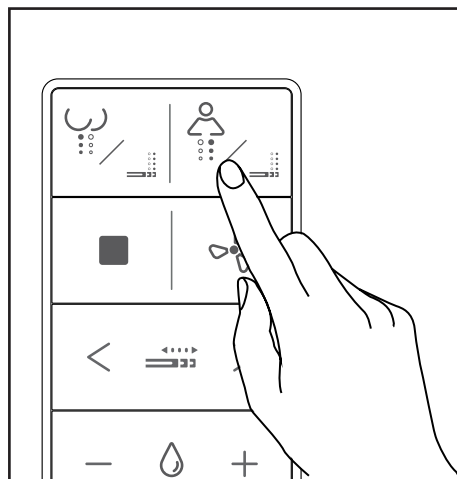

1. Press **FRONT WASH** button to activate front cleansing function. The wash cycle will start automatically and will run for 3 minutes.
2. The default cleaning mode is Fixed-Point Wash (nozzle remains in one position)
3. During the wash cycle, press the **FRONT WASH** button again to change the cleaning mode: Fixed Point Wash --> Moving Wash (nozzle moves back & forth) --> Moving + Massage Wash (moving wash + alternating strong/light water pressure) --> Massage Wash --> Fixed point Wash.
4. Press **STOP** button to discontinue at any point during its operation.

**Drying**

**Note:** Functions only when user is seated.

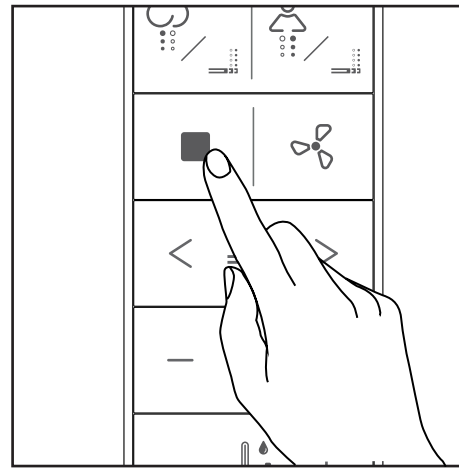
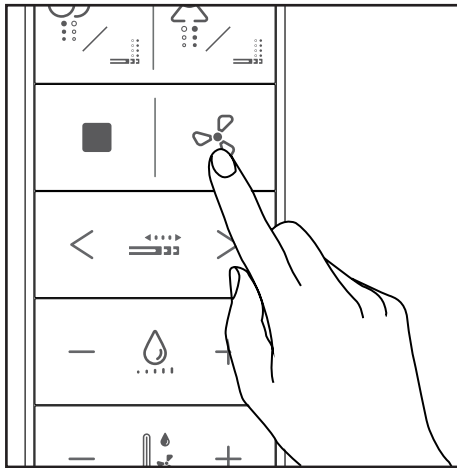

1. Press **DRY** button to activate drying function.
2. Drying operation will automatically continue for 3 minutes.
3. Press **STOP** button to discontinue at any point during its operation.

**Nozzle Position Control**

**Note:** Operates only during REAR or FRONT wash.

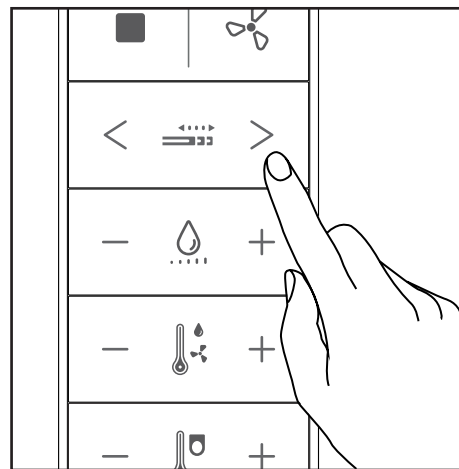
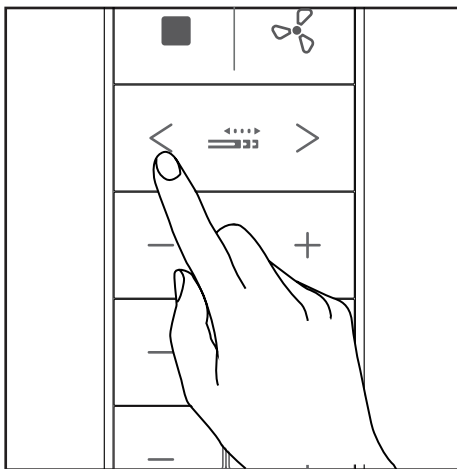

1. There are 5 nozzle position options.
2. Press ">" button to extend the nozzle forward by 1 step. The main unit will emit one beep sound for each step.
3. Press "<" button to retract the nozzle backward by 1 step. The main unit will emit one beep sound for each step.
4. When the nozzle reaches its maximum/minimum position, the main unit will emit two beep sounds. **DO NOT** attempt further extension/retraction beyond this point.

**Water Pressure Control**

**Note:** Operates only during REAR or FRONT wash.

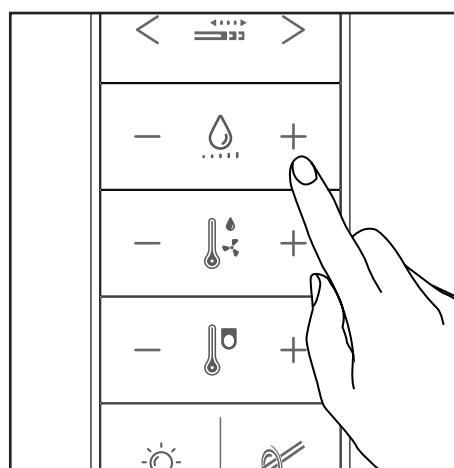
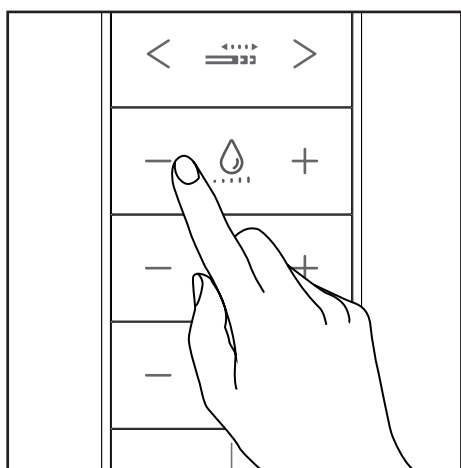

1. There are 5 water pressure level options.
2. Press "-" button to decrease the pressure by 1 level. The system buzzer will emit two beeps when the minimum level is reached.
3. Press "+" button to increase the pressure by 1 level. The system buzzer will emit two beeps when the maximum level is reached.

**Water Temperature / Drying Temperature Control**

**Note:** Operates only during REAR/FRONT wash or DRYING operation.

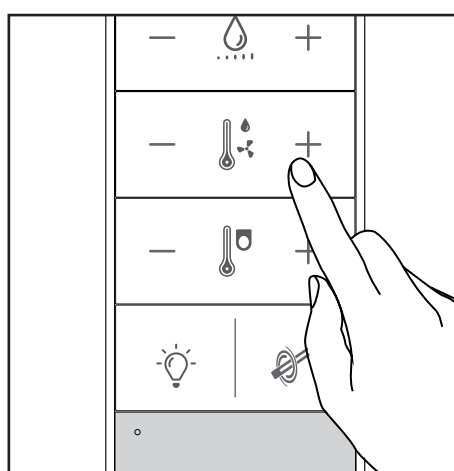
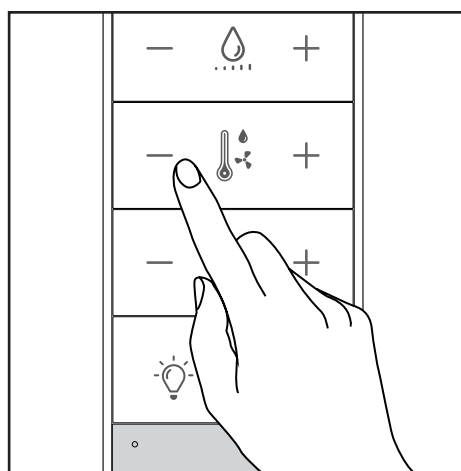

1. There are 6 water temperature options, i.e. OFF, 31°C, 33°C, 35°C, 37°C, 39°C.
2. There are 6 drying temperature options, i.e. OFF, 30°C, 35°C, 40°C, 45°C, 50°C.
3. Press "-" button to decrease the temperature by 1 level. The system buzzer will emit two beeps when the minimum level is reached.
4. Press "+" button to increase the temperature by 1 level. The system buzzer will emit two beeps when the maximum level is reached.

**Seat Temperature Control**

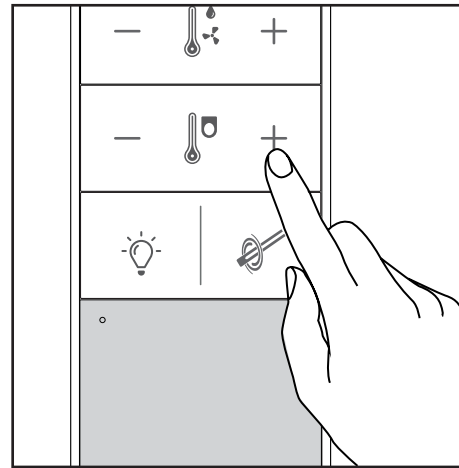
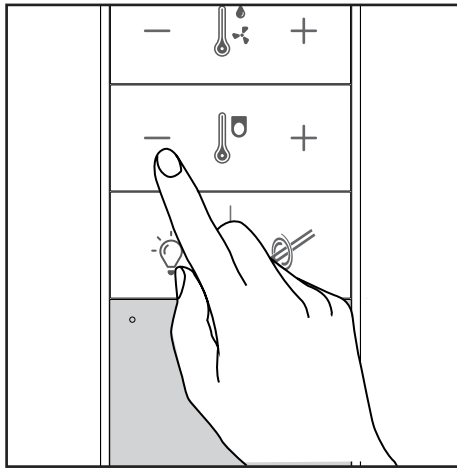

1. There are 6 seat temperature options, i.e. OFF, 30°C, 32°C, 34°C, 36°C, 38°C.
2. Press "-" button to decrease the temperature by 1 level. The system buzzer will emit two beeps when the minimum level is reached.
3. Press "+" button to increase the temperature by 1 level. The system buzzer will emit two beeps when the maximum level is reached.

**Night Light / Beeping Sound ON & OFF**

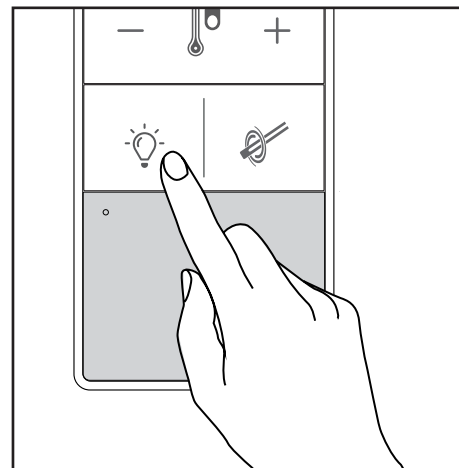
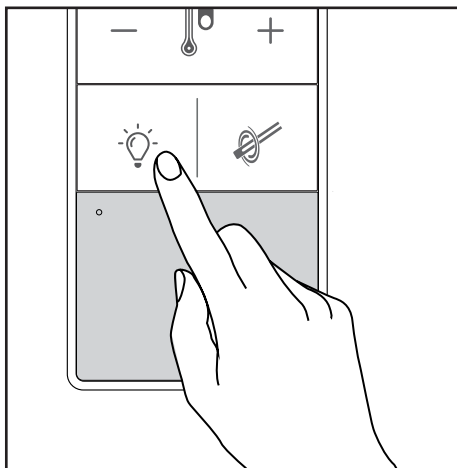

1. Short press **NIGHT LIGHT** button (for <3 seconds) to manually turn on/off the night light & ambient light.  
**Note:** The night light function is automatically controlled by the light sensor. The night light & ambient light are only turned on when the ambient illuminance is less than 2 Lux.
2. Long press **NIGHT LIGHT** button (for >3 seconds) to manually enable or disable the **BUZZER PROMPT** function.

**Nozzle Cleaning / Energy Saving Mode**

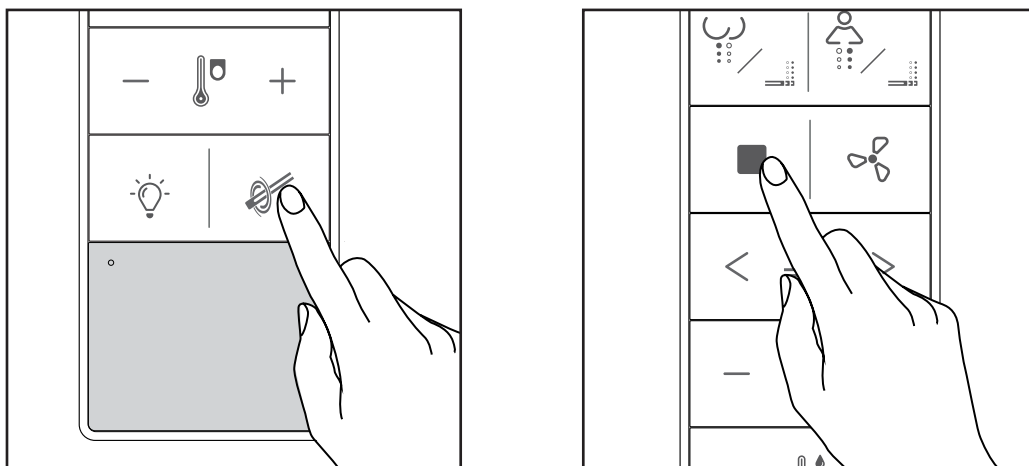

1. Short press **NOZZLE CLEANING** button (for <3 seconds) to extend the nozzle for cleaning & maintenance purpose.
2. Press **STOP** button after the nozzle cleaning is completed and the nozzle will retract.
3. If there is no operation or use of the bidet seat for more than one hour, it will automatically enter **ENERGY SAVING** mode. Alternatively, the bidet seat can be manually switched to **ENERGY SAVING** mode by long press **NOZZLE CLEANING** button (for >3 seconds).  
**Note:** In energy-saving mode, the seat temperature will be automatically adjusted to 25 °C.
4. When the bidet seat is in **ENERGY SAVING** mode, any use of the remote or the bidet seat will return the seat temperature to the previously set normal operating temperature.

**Auto Deodourisation**

1. Deodourisation function will start automatically when the seat is occupied and seat sensor is activated.
2. After the user vacates the seat, the deodourisation process continues for another 60 seconds.
3. Deodourisation function does not work during **FRONT/REAR** wash & **DRYING** operation.

## 5. CLEANING AND MAINTENANCE

### WARNING



Disconnect power plug

Disconnect the power plug while cleaning the product

Failure to do so may cause electric shock or injury.

### CAUTION



Prohibited

Never use acidic or alkaline toilet detergent, benzene, thinner, cleanser or nylon scrubber when cleaning the product

Doing so may damage plastic or metallic parts.

### 5.1 Main Unit Cleaning

1. Disconnect the power plug from the wall outlet.
2. Use only a soft and wet cloth (with warm water) when cleaning the main unit.
3. Clean with a soft and wet cloth (with neutral detergent) if the main unit is dirty, and wipe off the detergent with a wet cloth (with warm water).
4. Seat cover can be removed for deep cleaning (see below).
5. Connect the power plug to the wall outlet after the cleaning is completed.

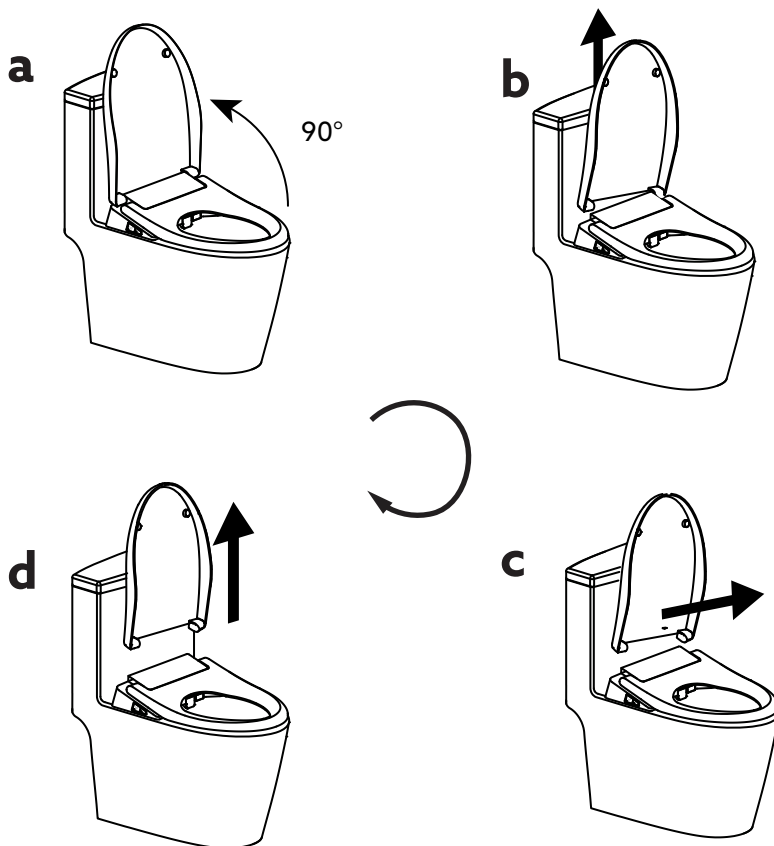

#### Seat Cover Removal Procedure

1. Open the seat cover to approximately 90° from the closed position.
2. Lift the left side of the seat cover upward until it disengages from the left-hand pivot shaft.
3. Slide the seat cover horizontally to the right to release it from the right-hand pivot shaft.
4. Remove the seat cover completely from the assembly.

#### Seat Cover Reassembly Procedure

1. Position the seat cover near the right-hand pivot shaft.
2. Align the seat cover with the right-hand pivot shaft and slide it horizontally to the left until fully engaged.
3. Lower the left side of the seat cover and press downward until it locks onto the left-hand pivot shaft.
4. Close the seat cover to confirm proper alignment and secure fit.

## 5.2 Water Filter Cleaning

1. Disconnect the power supply to the main unit.
2. Close the angle valve to stop water flow & unscrew the water inlet hose from the T-connector.
3. Remove the filter from the hose connection.
4. Clean the filter mesh using clean water and a soft brush to remove debris.
5. Reinstall the filter back into the hose connection after cleaning.

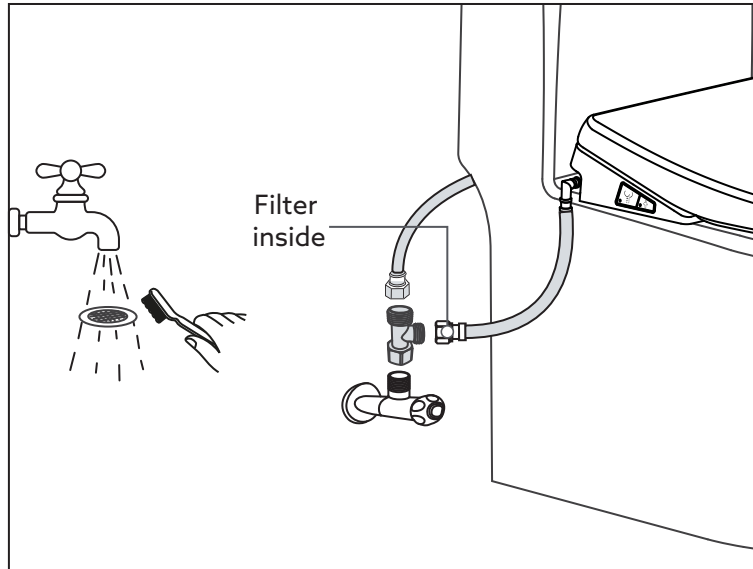

## 5.3 Nozzle Cleaning

1. Short press the **NOZZLE CLEANING** button on the remote to extend the nozzle out for cleaning & maintenance purpose.
2. Detach the spray head from the nozzle and clean it thoroughly with a soft cloth or brush with neutral detergent. Rinse with clean water.
3. Reinstall the spray head securely back into its original position on the nozzle and ensure proper alignment and tight fit.
4. Press **STOP** button on the remote and the nozzle will automatically retract into its resting position.

**Note: DO NOT** force to push the nozzle back manually, always use the **STOP** button.

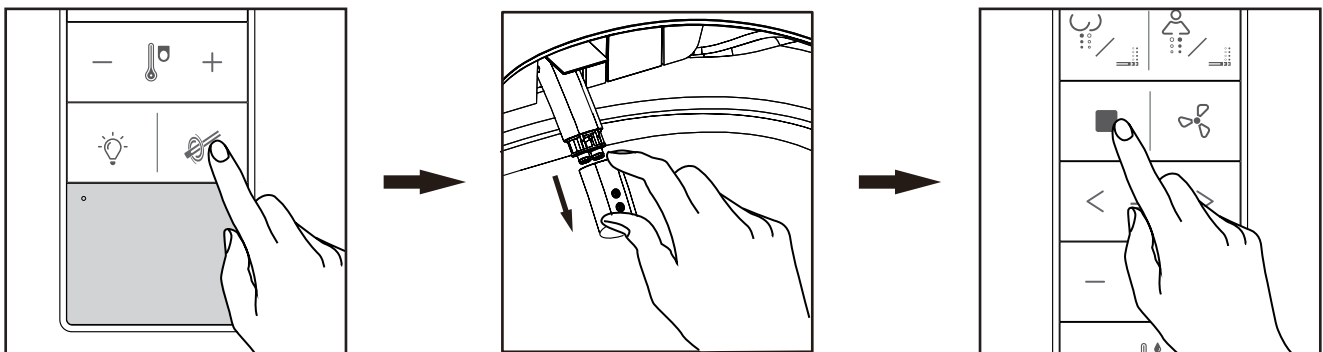

## 5.4 Deodorant Box Cleaning & Deodorant Catalyst Change

1. Disconnect the power supply & water inlet hose to the main unit.
2. Disassemble the bidet seat from the toilet to locate the deodorant box.
3. Use a flat-blade screwdriver to gently pry the bottom of deodorant box and remove it from the main unit.
4. Push out the deodorant catalyst using a small flat-blade screwdriver.
5. Replace with a new deodorant catalyst and insert it into the deodorant box.
6. If dust is present on the deodorant box, clean it using a toothbrush.
7. Place the deodorant box back into its original groove in the main unit.
8. Reinstall the bidet seat back to the toilet.

**Note:** it is recommended to replace the deodorant catalyst every 6 months.

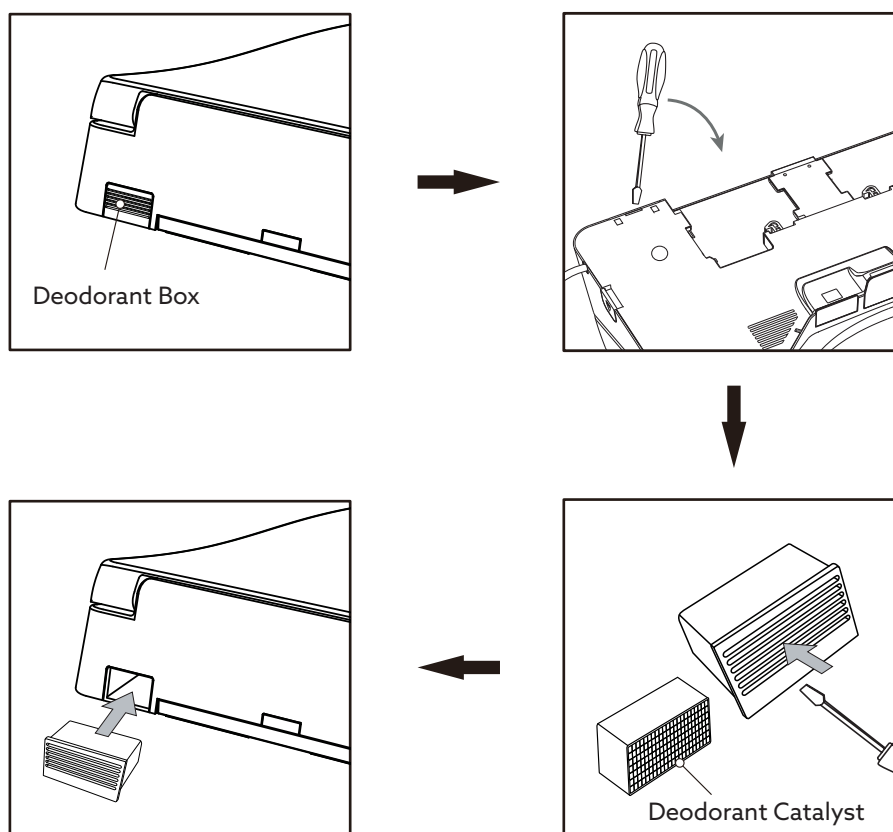

## 6. TROUBLE SHOOTING



### Warning

**DO NOT disassemble, repair or modify the product by yourself**





Failure to do so may cause electric shock, fire or malfunction.

If your device **still does not operate correctly after following all the instructions provided**, please contact a nearest **authorised service center** or **authorised dealer** for assistance.

Status	Causes	Solutions
Product is not working	Check if power outage	Wait for power supply
	Check if circuit breaker is tripped	Reset the circuit breaker
	Check if the plug is plugged in	Connect the plug
	Check if the product is in Stand-by mode	Change to Standard mode
Water leaks from nozzle before/after cleaning	Nozzle self-cleaning. The whole self-cleaning process lasts 5 seconds	This is not a product failure.
Indicator light on remote keeps flashing	Batteries are low	Replace batteries
Remote does not work	Batteries are low	Replace batteries
	No batteries in the remote	Load new batteries
	Batteries are positioned in wrong direction	Re-load the batteries
	Malfunction	Replace the remote
Nozzle does not extend	Check if the inlet hose is bended	Call a plumber for repair
	Check the water supply	Wait for water service to resume
	Check if the inlet hose is frozen	Increase ambient temperature or use hot & wet cloth to unfreeze.
Water pressure is too weak	Check if the filter mesh is dirty	Clean the filter mesh
	Check if the inlet hose is bended	Call a plumber for repair
	Check if the nozzle hole is blocked	Clean the nozzle
	Check if water pressure is set to Low	Set it to Medium or High

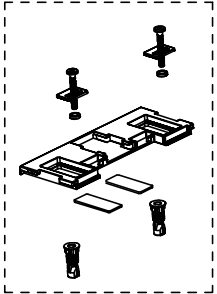
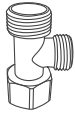
<b>Status</b>	<b>Causes</b>	<b>Solutions</b>
Seat is not warm enough.	Check if the product in Energy Saving mode	Exit Energy Saving mode, wait for 3~5 minutes
	Check if the seat has just been occupied for a short time	Wait for 3~5 minutes, it will get warm
	Check if the seat temperature is set to OFF or Low	Set temperature to Medium or High
Cleaning water is not warm enough	Check if the water temperature is set to OFF or Low	Set temperature to Medium or High
Drying stops during operation	Check if drying has been operating for more than 3 minutes.	Press the DRY button again
Drying temperature is not warm enough	Check if the drying temperature is set to OFF or Low	Set temperature to Medium or High
Deodorization does not working during cleaning & drying operation	Normal	Deodorization stops during cleaning & drying operation
Bad smell is not effectively removed.	Check if there is dust in the deodorant box or deodorant catalyst is overdue.	Clean the deodorant box or replace the deodorant catalyst
Deodoriation produces loud noise.	Check if there is dust in the deodorant box or deodorant catalyst is overdue.	Clean the deodorant box or replace the deodorant catalyst

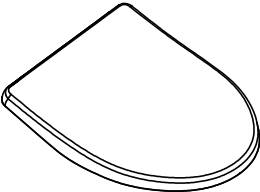
## 7. SPARE PART LIST

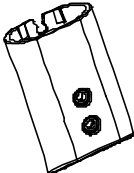
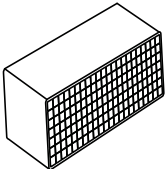
Part	Part name	SKU#
	Mounting plate fixing kit	1667251
	T connector	1667252
	Water inlet hose + hose clamp	1667253
	Remote	1667254
	Seat cover	1667255
	Bumper - seat cover	1667256
	Bumper - seat ring	1667257
	Spray head	1667258
	Deodorant catalyst	1667259

## **CONTACT AND WARRANTY INFORMATION:**

---

### **NEW ZEALAND**

**KOHLER NEW ZEALAND LTD**

0800 100 382

info@englefield.co.nz

englefield.co.nz

### **AUSTRALIA**

englefield.com

For warranty information, please visit our website.

