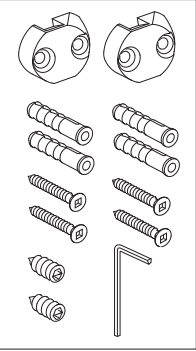
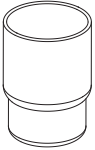
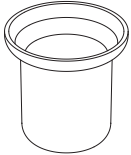
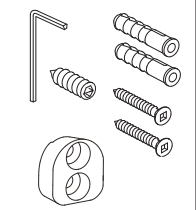
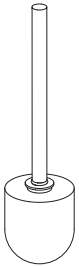
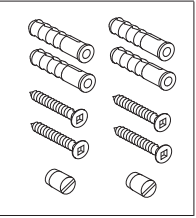

SPARE PARTS LIST

 <p>Glass Soap dish 1259729</p>	 <p>Valencia accessories fixing kit 1 1267295</p> <p>For use with: -Valencia double towel rail -Valencia single towel rail -Valencia hand towel rail -Valencia toilet roll holder</p>
 <p>Glass Tumbler 1259730</p>	
 <p>Glass toilet brush holder 1259731</p>	 <p>Valencia accessories fixing kit 2 1267296</p> <p>For use with: -Valencia robe hook -Valencia tumbler holder -Valencia soap dish holder -Valencia toilet brush holder</p>
 <p>Toilet brush 1259732</p>	 <p>Glass shelf fixing kit 1267294</p> <p>For use with: -Valencia glass shelf</p>

CONTACT AND WARRANTY INFORMATION

NEW ZEALAND
KOHLER NZ LTD

Free Ph: 0800 100 382
Free Fax: 0800 664 488
www.Englefield.co.nz

AUSTRALIA
KOHLER CO.

Free Ph: 1 800 ENGLEFIELD
(1 800 364 533)
www.Englefield.com

For warranty information, please visit our website.



INSTALLATION INSTRUCTIONS



ACCESSORIES

VALENCIA™ Accessory Range

BEFORE YOU BEGIN

Before proceeding with the installation, please read these instructions carefully to familiarise yourself with the required tools and materials, and to ensure proper care and installation of the accessory.

Prior to installation, inspect the accessory to ensure that no damage has occurred in transit. If damage has occurred, or a visible defect exists, do not proceed with installation, and advise your supplier immediately.

Please keep these instructions for future reference.

CAUTION

1. Do not install where the product might be used as a grab or support bar.
2. Prior to drilling into walls, check there are no hidden electrical wires, cables or water supply pipes with the aid of an electronic detector.
3. These accessories are designed to be mounted to a wall and it is strongly recommended that the product is installed on a stud, noggin or to concrete.
4. When mounting to a stud or noggin we recommend using an electronic stud finder to locate studs before installation.
5. Wear safety glasses when drilling.



If you are building a bathroom from scratch, giving your bathroom a makeover or just replacing an old tap, Englefield can provide a solution for you.

TOOLS & MATERIALS REQUIRED - (Not supplied)

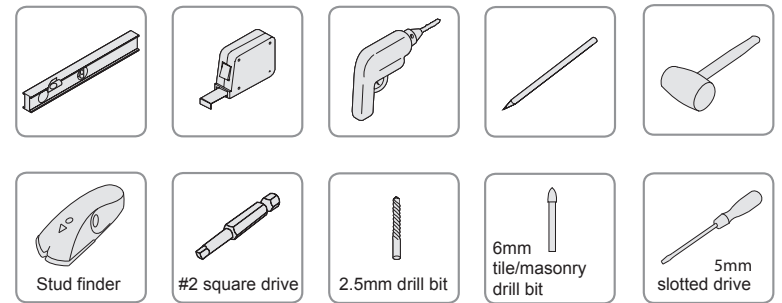

1. LOCATING AND MARKING

Select an appropriate location to install the accessory.



It is strongly advised to install the product on a solid base, and the use of an electronic stud finder is recommended for stud/nog installation. (Fig. 1)

NOTE: Refer to assembled accessory for bracket alignment and orientation.

• For accessories with one bracket

Use a level to ensure the holes are aligned either horizontally or vertically and that the bracket is correctly oriented with tapered holes facing you (Fig. 2 & 3). Mark the location of the holes with a sharpened pencil.

• For accessories with two brackets

Towel rails: A hole location template is provided (Fig. 4). Select a location to place the template. Use a level to ensure that the template is horizontal. Ensure it is pressed flat and fix the template to the wall.

Glass shelf: The bracket positions on the glass shelf are adjustable. Choose an appropriate bracket distance (400mm minimum). Use a level to ensure that the brackets are horizontal. Mark the location of the holes with a sharpened pencil. (Fig. 5)

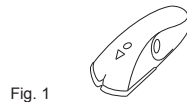

Fig. 1

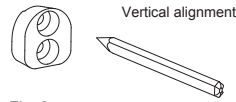

Fig. 2

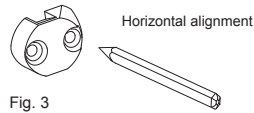

Fig. 3



Fig. 4

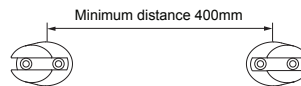

Fig. 5

2. BRACKET INSTALLATION

NOTE: When drilling holes make sure to do so as accurately as accurately as possible.

Stud or a nog installation (Fig. 6)

• Pre-drill 2.5mm diameter pilot holes at the marked locations. When using the installation template, drill directly through the template on the marked locations, then remove the template.

• Align the bracket/s so that it is correctly oriented and secure the bracket in place with the supplied screws using a #2 square drive.

• Ensure that the screws are firmly fastened.

Ceramic tile or concrete installation (Fig. 7)

• Drill 6mm diameter holes at the marked locations using a tungsten carbide tipped drill bit for tiles, or a masonry bit for concrete.

• Gently tap the supplied toggles into the holes using a mallet until they are fully inserted.

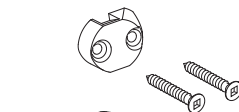

Fig. 6

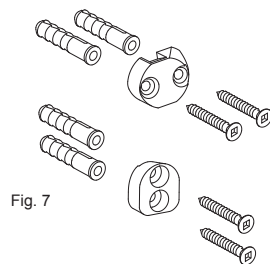

Fig. 7

- Orient the bracket correctly over the wall plugs and ensure the recesses on the back of the bracket fit over the rim of the wall plugs so that the bracket is flush with the wall
- Secure the bracket firmly in place with the supplied screws using a #2 square drive.

Plaster board installation

Please consult your local hardware store for appropriate wall plugs for installation on plaster board.

3. ACCESSORY INSTALLATION

Step 3.1

NOTE: For all accessories ensure that the grub screw hole is oriented downwards.

• For the tumbler holder, soap dish holder, toilet brush holder & single robe hook.

Slide the accessory over the bracket so that the top of the bracket sits in the groove as shown. (Fig. 8)

• For the toilet roll holder

Slide the toilet roll holder onto the bracket. (Fig. 9)

• For the single towel rail, double towel rail & hand towel rail

Slide the assembled towel rail over the fixed brackets. (Fig. 10)

• For the glass shelf

Slide the glass shelf into the bracket slots and center. (Fig. 11)

Step 3.2

Align and firmly press the accessory against the wall while screwing in the grub screw/s with the provided hex key. Make sure the grub screw/s are firmly tightened.

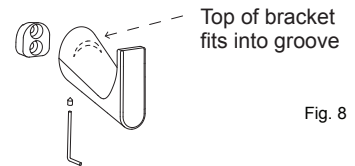

Fig. 8

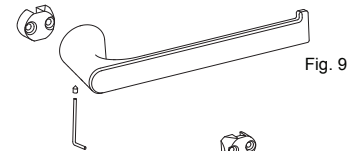

Fig. 9

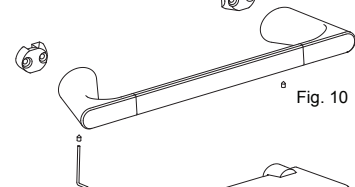

Fig. 10

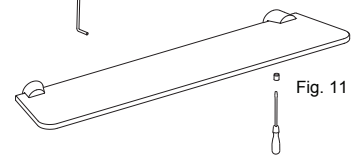

Fig. 11

4. CHECK INSTALLATION

Ensure that all connections are tight. Place glass components onto appropriate accessories.

CLEANING INSTRUCTIONS

Clean accessories with mild soap and warm water. Wipe entire surface completely dry with a clean soft cloth. Harsh cleaning products including those that contain ammonia and chlorine may adversely affect the finish and are not recommended for cleaning.